



BAR 5.1 SURROUND



OWNER'S MANUAL

IMPORTANT SAFETY INSTRUCTIONS

Verify Line Voltage Before Use

The JBL Bar 5.1 Surround (soundbar and subwoofer) has been designed for use with 100-240 volt, 50/60 Hz AC current. Connection to a line voltage other than that for which your product is intended can create a safety and fire hazard and may damage the unit. If you have any questions about the voltage requirements for your specific model or about the line voltage in your area, contact your retailer or customer service representative before plugging the unit into a wall outlet.

Do Not Use Extension Cords

To avoid safety hazards, use only the power cord supplied with your unit. We do not recommend that extension cords be used with this product. As with all electrical devices, do not run power cords under rugs or carpets, or place heavy objects on them. Damaged power cords should be replaced immediately by an authorized service center with a cord that meets factory specifications.

Handle the AC Power Cord Gently

When disconnecting the power cord from an AC outlet, always pull the plug; never pull the cord. If you do not intend to use this speaker for any considerable length of time, disconnect the plug from the AC outlet.

Do Not Open the Cabinet

There are no user-serviceable components inside this product. Opening the cabinet may present a shock hazard, and any modification to the product will void your warranty. If water accidentally falls inside the unit, disconnect it from the AC power source immediately, and consult an authorized service center.

TABLE OF CONTENTS

IMPORTANT SAFETY INSTRUCTIONS	2	7. SOUND SETTINGS	14
1. INTRODUCTION	4	8. RESTORE FACTORY SETTINGS	15
2. WHAT'S IN THE BOX	4	9. SOFTWARE UPDATE	15
3. PRODUCT OVERVIEW	5	10. RE-CONNECT THE SUBWOOFER	16
3.1 SOUNDBAR	5	11. PRODUCT SPECIFICATIONS	16
3.2 SUBWOOFER	6	12. TROUBLESHOOTING	17
3.3 REMOTE CONTROL	6	13. TRADEMARKS	19
4. PLACE	7	14. OPEN SOURCE LICENSE NOTICE	20
4.1 DESKTOP PLACEMENT	7		
4.2 WALL-MOUNTING	7		
5. CONNECT	8		
5.1 TV CONNECTION	8		
5.2 DIGITAL DEVICE CONNECTION	8		
5.3 CONNECTION WITH YOUR HOME NETWORK	8		
5.4 BLUETOOTH CONNECTION	10		
6. PLAY	11		
6.1 POWER-ON/AUTO STANDBY/AUTO WAKEUP	11		
6.2 FIRST-TIME SETUP	11		
6.3 PLAY FROM THE TV SOURCE	12		
6.4 PLAY FROM THE HDMI IN SOURCE	12		
6.5 PLAY FROM THE BLUETOOTH SOURCE	13		
6.6 PLAY THROUGH CHROMECAST	13		
6.7 PLAY THROUGH AIRPLAY	13		
6.8 MULTI-ROOM PLAYBACK	13		

1. INTRODUCTION

Thank you for purchasing the JBL Bar 5.1 Surround (soundbar and subwoofer) which is designed to bring an extraordinary sound experience to your home entertainment system. We encourage you to take a few minutes to read through this manual, which describes the product and includes step-by-step instructions for setting up and getting started.

This product may have an important software update available. Please follow the instructions to connect the product to the Internet to ensure that your product has the latest updates.

Designs and specifications are subject to change without notice. If you have any questions about the soundbar, installation or operation, please contact your retailer or customer service representative, or visit our website: www.jbl.com.

2. WHAT'S IN THE BOX

Unpack the box carefully and ensure that the following parts are included. If any part is damaged or missing, do not use it and contact your retailer or customer service representative.

Sound bar



Subwoofer

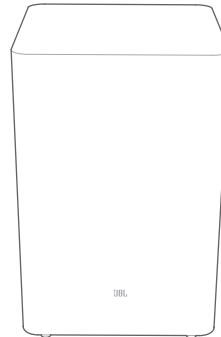

Remote control (with 2 AAA batteries)

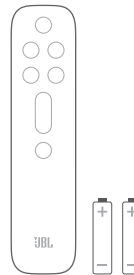

Power cord*

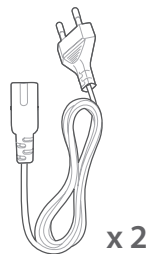

* Power cord quantity and plug type vary region.

HDMI cable



Wall-mounting kit

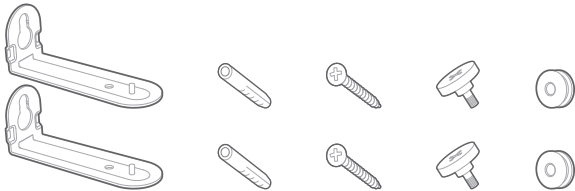

Product information & wall-mounting template



3. PRODUCT OVERVIEW

3.1 Soundbar

Controls

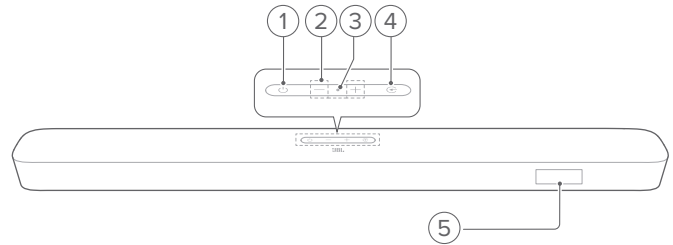

- 1) **⏻ (Power)**
 - Switch on or to standby
- 2) **-/+ (Volume)**
 - Decrease or increase the volume
 - Press and hold to decrease or increase the volume continuously.
 - Press the two buttons together to mute or unmute.
- 3) **🎤 (Microphone)**
 - For audio calibration (Automatic Multibeam Calibration (AMC))
- 4) **📺 (Source)**
 - Select a sound source: TV (default, for TV connection where the **HDMI OUT (TV ARC)** connector is prioritized over the **OPTICAL** connector), Bluetooth or HDMI IN
- 5) **Status display**

Rear connectors

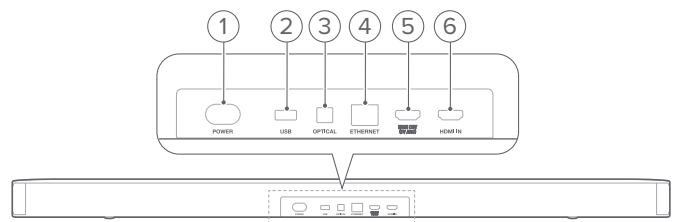

- 1) **POWER**
 - Connect to power (with the supplied power cord)
- 2) **USB**
 - USB connector for software update
 - Connect to a USB storage device for MP3 file playback (for US version only)
- 3) **OPTICAL**
 - Connect to the optical output on your TV or digital device
- 4) **ETHERNET**
 - Connect to your home network through an Ethernet cable

5) HDMI OUT (TV ARC)

- Connect to the HDMI ARC input on your TV

6) HDMI IN



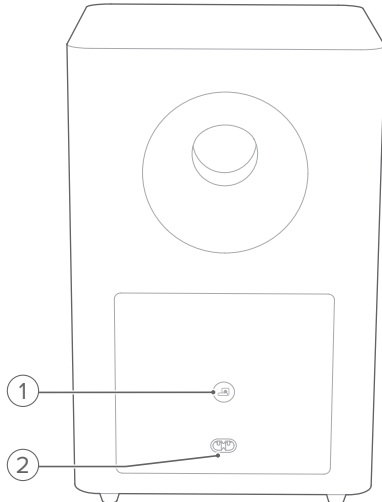

- Connect to the HDMI output on your digital device

3.2 Subwoofer



1)

- Connection status indicator

	Solid white	Connected to the soundbar
	Fast flashing white	Pairing mode
	Slow flashing white	Reconnecting or exiting the pairing mode
	Solid amber	Standby mode

2) POWER

- Connect to power (with the supplied power cord)

3.3 Remote control

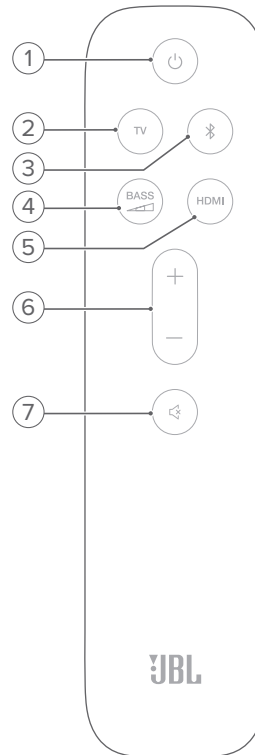

1)

- Switch on or to standby

2) TV

- Select the TV source (for TV connection where the **HDMI OUT (TV ARC)** connector is prioritized over the **OPTICAL** connector)

3) (Bluetooth)

- Select the Bluetooth source
- Press and hold to connect another Bluetooth device

4)

- Select the bass level for subwoofer: 1/2/3 (default)/4/5

5) HDMI

- Select the **HDMI IN** source

6) + / -

- Increase or decrease the volume
- Press and hold to increase or decrease the volume continuously.

7) (Mute)

- Mute/unmute

4. PLACE

4.1 Desktop placement

Place the soundbar and subwoofer on a flat and stable surface. Make sure that the subwoofer is at least 3 ft (1 m) away from the soundbar, and 4" (10 cm) away from the wall.

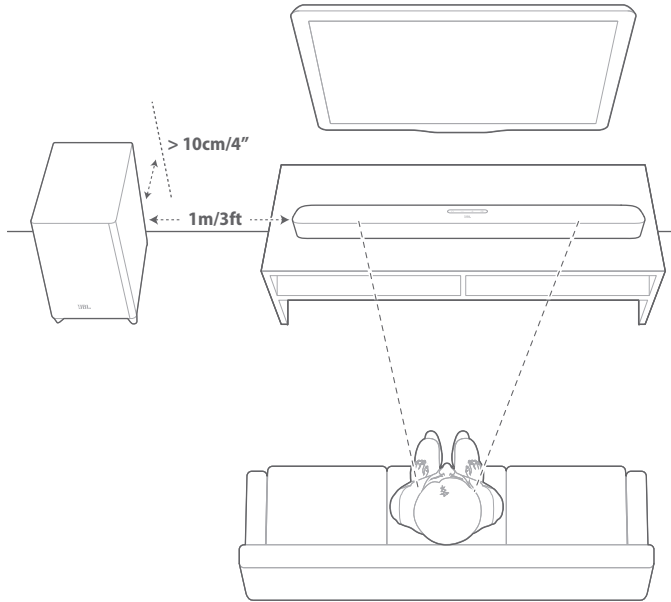

NOTES:

- The power cord shall be properly connected to power.
- Do not place any objects on the top of the soundbar or subwoofer.
- Make sure that the distance between the subwoofer and the soundbar is less than 20 ft (6 m).

4.2 Wall-mounting

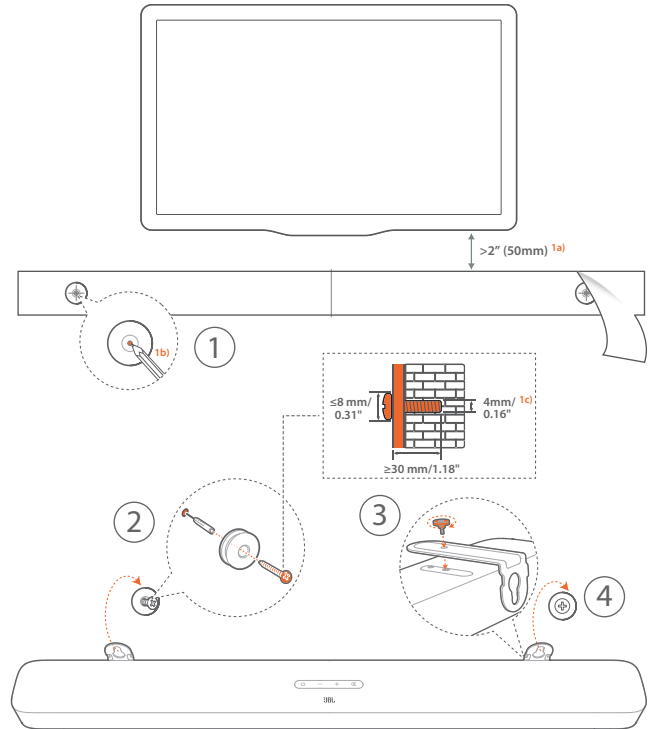

1. Preparation:

- a) With a minimum distance of 2" (50mm) from your TV, stick the supplied wall-mounting template to a wall by using adhesive tapes.
- b) Use your ballpen tip to mark the screw holder location. Remove the template.
- c) On the marked location, drill a 4 mm/0.16" hole.

2. Install the support for wall-mounting bracket.

3. With the screw, fasten the wall-mounting bracket onto the bottom of the soundbar.

4. Mount the soundbar.

NOTES:

- Make sure that the wall can support the weight of the soundbar.
- Install on a vertical wall only.
- Avoid a location under high temperature or humidity.
- Before wall-mounting, make sure that cables can be properly connected between the soundbar and external devices.
- Before wall-mounting, make sure that the soundbar is unplugged from power. Otherwise, it may cause an electric shock.

5. CONNECT

5.1 TV connection

Connect the soundbar with your TV through the supplied HDMI cable or an optical cable (sold separately).

Through the supplied HDMI cable

An HDMI connection supports digital audio and video with a single connection. HDMI connectivity is the best option for your soundbar.

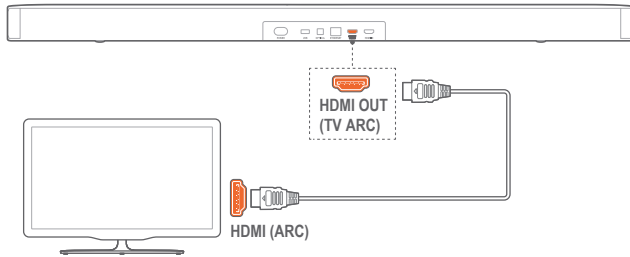

1. Connect the soundbar with your TV by using the supplied HDMI cable.
2. On your TV, check that HDMI-CEC and HDMI ARC have been enabled. Refer to the owner's manual of your TV for more information.

NOTES:

- Full compatibility with all HDMI-CEC devices is not guaranteed.
- Contact your TV manufacturer if you have problems with the HDMI-CEC compatibility of your TV.

Through an optical cable

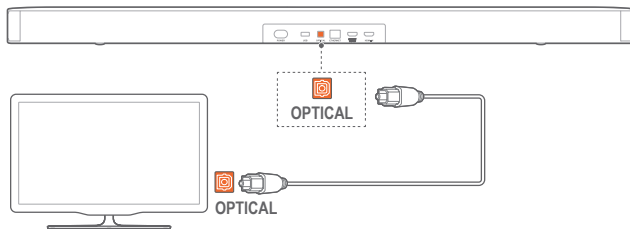

- Connect the soundbar with your TV by using an optical cable (sold separately).

5.2 Digital device connection

1. Make sure that you have connected your TV to the soundbar through the HDMI ARC connection (See “Through the supplied HDMI cable” under “TV connection” in the “CONNECT” chapter).
2. Use an HDMI cable (V2.0 or later) to connect the soundbar with your digital device, such as a set-top box, DVD/Blu-ray player or game console.
3. On your digital device, check that HDMI-CEC has been enabled. Refer to the owner's manual of your digital device for more information.

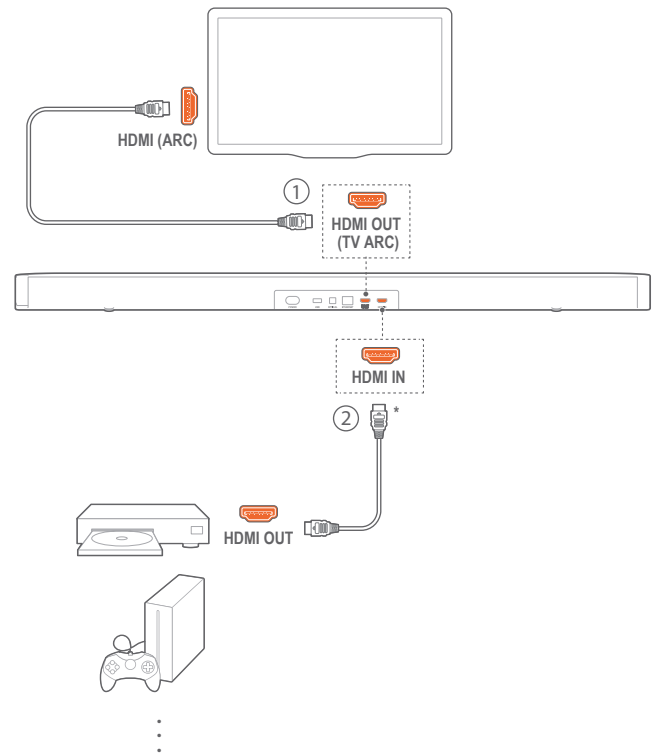

NOTES:

- * The HDMI cable is sold separately.
- Contact your digital device manufacturer if you have problems with the HDMI-CEC compatibility of your digital device.
- When both HDMI ARC and optical cables are connected to the soundbar, the audio output of HDMI ARC connection is prioritized.

5.3 Connection with your home network

Through Wi-Fi or an Ethernet cable, connect the soundbar to your home network. With Chromecast built-in, AirPlay and Alexa supported, the soundbar allows you to stream audio on smartphones or tablets through the soundbar speakers.

1. On the soundbar, enter the Wi-Fi setup mode:
 - Press \odot to switch on (See “Power-on/Auto standby/Auto wakeup” in the “PLAY” chapter).
→ If the soundbar has not been connected to a network, the screen shows “HELLO” and then, “SETUP WIFI”.
 - To re-enter the Wi-Fi setup mode, press and hold \odot until “RESET WIFI” is displayed.
2. On your Android or iOS device, add the soundbar to your home Wi-Fi network.

Through the Google Home app

- a) Connect your Android or iOS device to your home Wi-Fi network. Download the Google Home app. Sign in with your Google account. If you do not have, create a new one.
- b) Follow the app instructions to complete setup.



***Through the AirPlay speaker setup**

- a) Connect your iOS device to your home Wi-Fi network.
- b) On your iOS device, go to **Settings > Wi-Fi**. Under **SET UP NEW AIRPLAY SPEAKER...**, select **"JBL Bar 5.1_xxxx"** and follow onscreen instructions to complete setup.

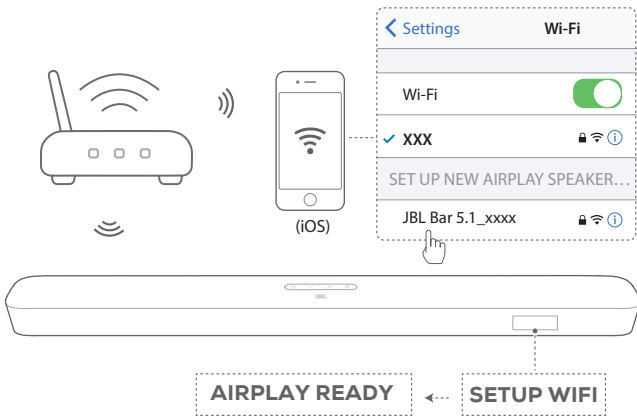

****Through the JBL BAR Setup app**

- a) Connect your Android or iOS device to your home Wi-Fi network. Download the JBL BAR Setup app.
- b) With the JBL BAR Setup app, connect the soundbar to your home Wi-Fi network and sign in with your Amazon account. Follow the app instructions to complete setup.



b) iOS

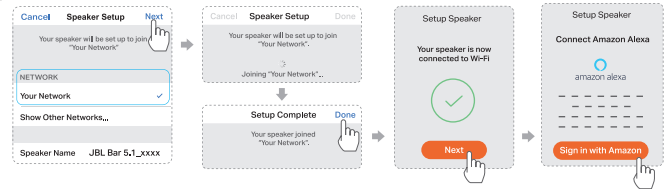

Android



3. If necessary, use an Ethernet cable to connect the soundbar to your home network.
 - Make sure that you connect to the same network as you did during the setup.

NOTES:

- During the Wi-Fi setup through the Google Home app, you can name the soundbar and organize it by room.
- On your iOS device, add the soundbar to the Apple Home app and manage it together with other AirPlay 2-compatible speakers.
- *On your iOS device, if the soundbar has been added to your home Wi-Fi network through the Google Home app, skip the steps under **"Through AirPlay speaker setup"** and you can start AirPlay streaming from an AirPlay-compatible app (See "Play through AirPlay" in the "PLAY" chapter).
- **The function is available after the software update is completed on the soundbar.
- **The JBL BAR Setup app is only for you to set up Wi-Fi to play music through Alexa MRM (Multi-Room Music). For music playback through Alexa MRM, create a Multi-Room Music group for the soundbar through the Amazon Alexa app (See "6.8.3 Alexa MRM: Multi-Room Music" under "6.8 Multi-room playback" in the "6. PLAY" chapter).
- **If the soundbar has been added to your home Wi-Fi network through the Google Home app or the AirPlay speaker setup, use the JBL BAR Setup app to sign in with your Amazon account. Follow the steps as shown in the diagram below.

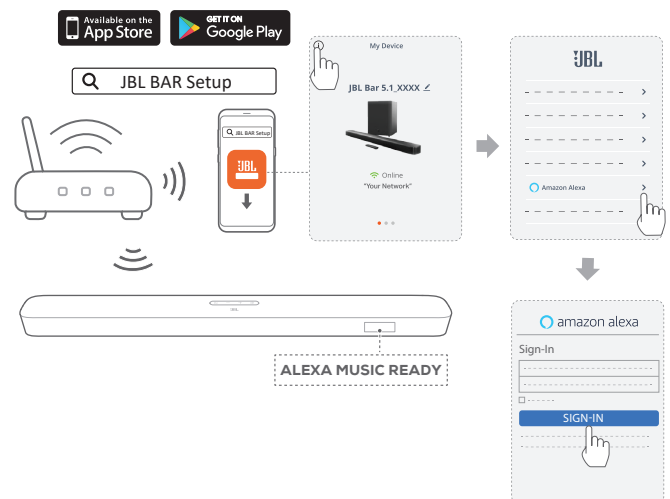

5.4 Bluetooth connection

Through Bluetooth, connect the soundbar with your Bluetooth device, such as a smartphone, tablet and laptop.

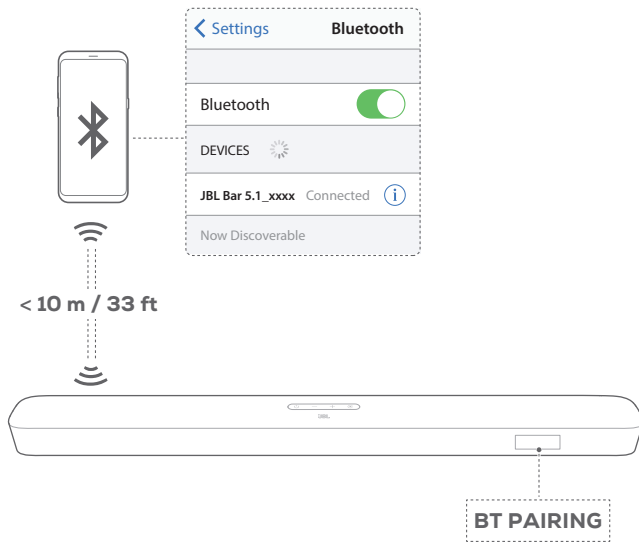

Connect a Bluetooth device

1. Press **⏻** to switch on (See “Power-on/Auto standby/Auto wakeup” in the “PLAY” chapter).
2. To select Bluetooth source, press **Ⓞ** on the soundbar or **Ⓞ** on the remote control.
→ “**BT PAIRING**”: Ready for BT pairing
3. On your Bluetooth device, enable Bluetooth and search for “**JBL Bar 5.1_xxxx**” within three minutes.
→ **Successful connection**: The device name is displayed if your device is named in English. A confirmation tone is heard.

To reconnect the last paired device

Your Bluetooth device is retained as a paired device when the soundbar goes to standby mode. Next time you switch to the Bluetooth source, the soundbar reconnects the last paired device automatically.

To connect to another Bluetooth device

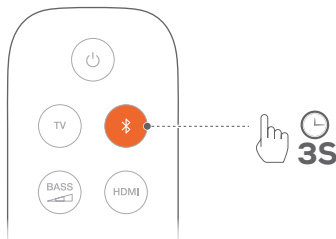

1. In the Bluetooth source, press and hold **Ⓞ** on the soundbar or **Ⓞ** on the remote control until “**BT PAIRING**” is displayed.
→ The previously paired device is cleared from the soundbar.
→ The soundbar enters the Bluetooth pairing mode.

2. Follow the Step 3 under “Connect a Bluetooth device”.
 - If the device has ever been paired with the soundbar, first unpair “**JBL Bar 5.1_xxxx**” on the device.

NOTES:

- The Bluetooth connection will be lost if the distance between the soundbar and Bluetooth device exceeds 33 ft (10 m).
- Electronic devices may cause radio interference. Devices that generate electromagnetic waves must be kept away from the Soundbar, such as microwaves and wireless LAN devices.

6. PLAY

6.1 Power-on/Auto standby/Auto wakeup

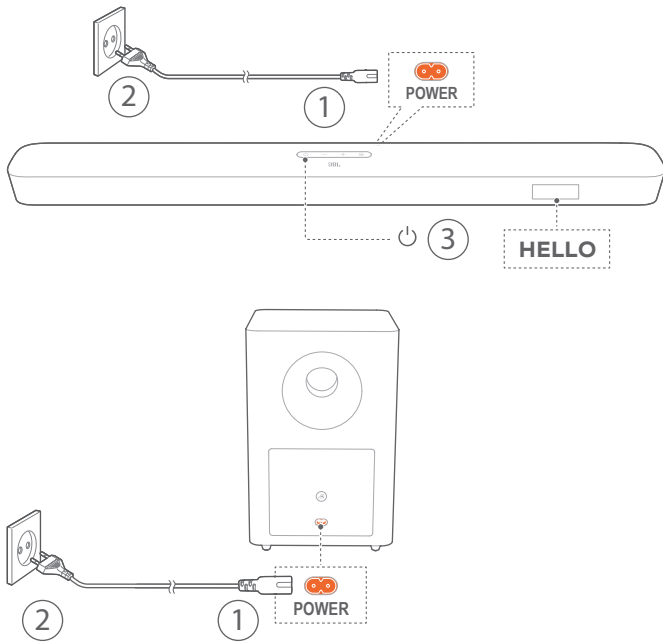

Switch on

1. Connect the soundbar and subwoofer to power by using the supplied power cords.
 - The screen on the soundbar shows “LOAD” and then, “STDBY”.
2. On the soundbar, press to switch on.
 - “HELLO” is displayed.
 - The subwoofer is connected to the soundbar automatically. **Connected:** turns solid white.

NOTES:

- Use the supplied power cords only.
- Before connecting to power, make sure that you have properly plugged the power cords into the soundbar and subwoofer.
- Before switching on the soundbar, make sure that you have completed all other connections (See “TV connection” and “Digital device connection” in the “Connect” chapter).

Auto standby

If the soundbar is inactive for more than 10 minutes, it will switch to standby mode automatically. “STDBY” is displayed. The subwoofer also goes to standby, and turns solid amber.

Next time you switch on the soundbar, it returns to the last selected source.

Auto wakeup

In standby mode, the soundbar will wake up automatically when

- the soundbar is connected to your TV through the HDMI ARC connection and your TV is switched on;
- the soundbar is connected to your TV through an optical cable and audio signals are detected from the optical cable;

- the soundbar is connected to your TV through the HDMI ARC connection and through the HDMI connection, is also connected to your digital device such as a set-top box, DVD/Blu-ray player or game console, and your digital device is switched on;
- the soundbar is connected to your home network and audio is streamed to the soundbar through Chromecast or AirPlay.

6.2 First-time setup

Automatic Multibeam Calibration

With Automatic Multibeam Calibration (AMC), your surround sound experience can be optimized for your favorite seating position.

- On the remote control, press and hold **HDMI** until “CALIBRATION” is displayed on the soundbar.
 - Countdown starts from 5 to 1.
 - Loud sound is heard. Audio calibration starts.
 - “CALIBRATING”: Calibration ongoing.
 - “DONE”: Calibration completed successfully.

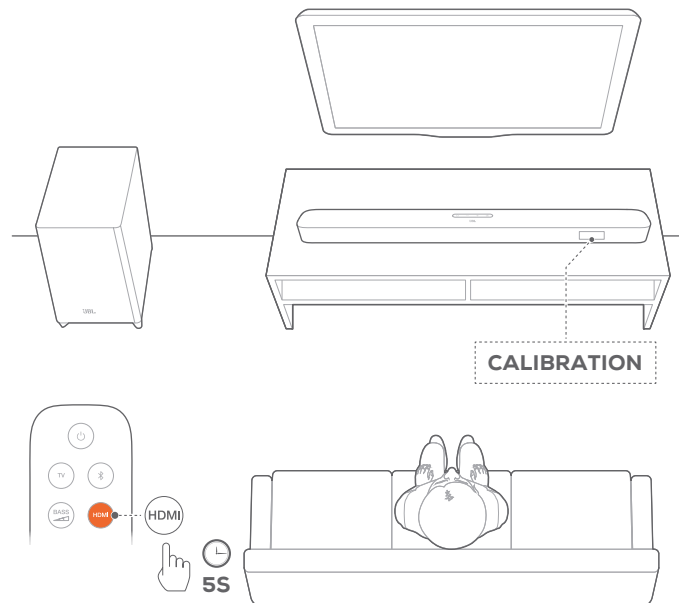

NOTES:

- During AMC, all buttons on the remote control are disabled except for and **HDMI**.
- “FAILED” is displayed if AMC failed.

6.3 Play from the TV source

With the soundbar connected, you can enjoy TV audio from the soundbar speakers.

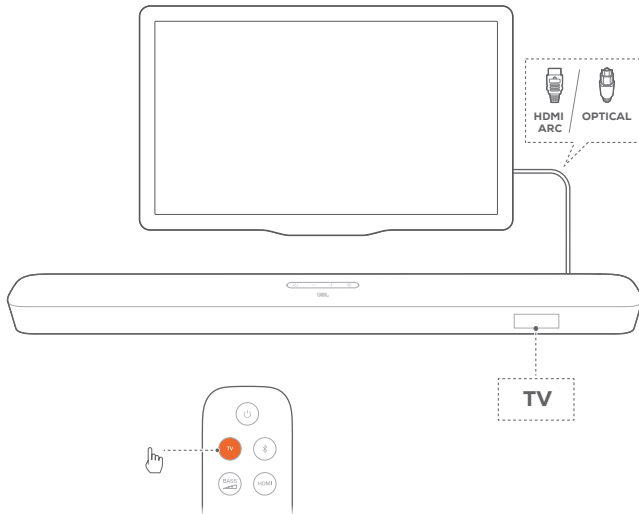

1. Make sure that your TV is set to support external speakers and the built-in TV speakers are muted. Refer to the owner's manual of your TV for more information.
2. Make sure that the soundbar has been properly connected to your TV (See "TV connection" in the "CONNECT" chapter).
3. To select the TV source, press **G** on the soundbar or **TV** on the remote control.
 - "TV": The TV source is selected.
 - In the factory settings, the TV source is selected by default.

NOTES:

- If the soundbar is connected to your TV through both an HDMI cable and an optical cable, the HDMI cable is selected for the TV connection.

6.3.1 TV remote control setup

To use your TV remote control for both your TV and the soundbar, check that your TV supports HDMI-CEC. If your TV does not support HDMI-CEC, follow the steps under "TV remote control learning".

HDMI-CEC

If your TV supports HDMI-CEC, enable the functions as instructed in your TV user manual. You can control the volume +/-, mute/unmute, and power on/standby functions on your soundbar through the TV remote control.

TV remote control learning

1. On the soundbar, press and hold **G** and **+** until "LEARNING" is displayed.
 - You enter the TV remote control learning mode.

2. Within 15 seconds, do the following on the soundbar and your TV remote control:
 - a) On the soundbar: press one of the following buttons **+**, **-**, **+** and **-** together (for the mute/unmute function), and **G**.
 - b) On your TV remote control: press the desired button.
 - "WAIT" is displayed on the soundbar.
 - "DONE": The function of the soundbar button is learnt by your TV remote control button.
3. Repeat Step 2 to complete the button learning.
4. To exit the TV remote control learning mode, press and hold **G** and **+** on the soundbar until "EXIT LEARNING" is displayed.
 - The soundbar returns to the last selected source.

6.4 Play from the HDMI IN source

With the soundbar connected as shown, your digital device can play video on your TV and audio from the soundbar speakers.

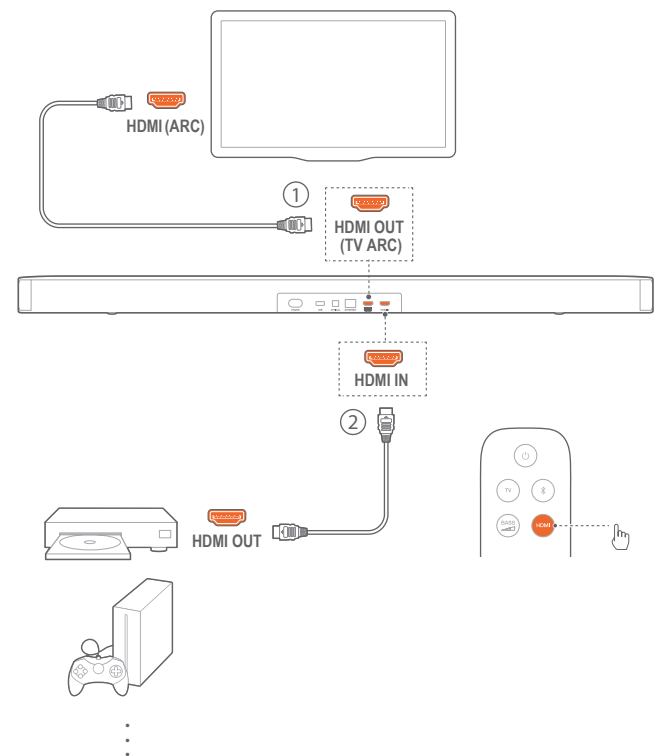

1. Make sure that the soundbar has been properly connected to your TV and digital device (See "TV connection" and "Digital device connection" in the "CONNECT" chapter).
2. Switch on your digital device.
 - Your TV and the soundbar wake up from standby mode and switch to the input source automatically.
 - To select the **HDMI IN** source on the soundbar, press **G** on the soundbar or **HDMI** on the remote control.
3. Switch your TV to standby mode.
 - The soundbar and source device are switched to standby mode.

NOTES:

- Full compatibility with all HDMI-CEC devices is not guaranteed.

6.5 Play from the Bluetooth source

Through Bluetooth, stream audio play on your Bluetooth device to the soundbar.

1. Check that the soundbar has been properly connected to your Bluetooth device (See “Bluetooth connection” in the “CONNECT” chapter).
2. To select the Bluetooth source, press **G** on the soundbar or **B** on the remote control.
3. Start audio play on your Bluetooth device.
4. Adjust the volume on the soundbar or your Bluetooth device.

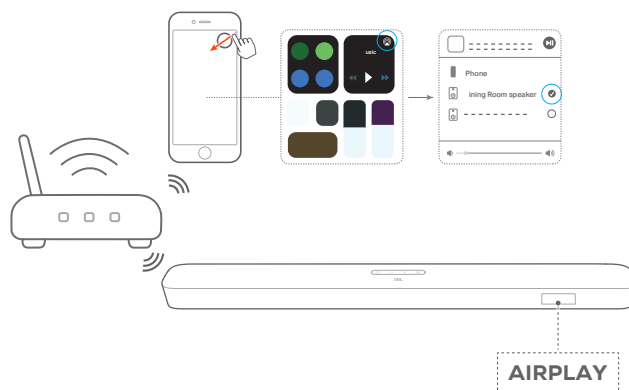

6.6 Play through Chromecast

Through Chromecast, stream audio on your Android or iOS device to the soundbar.

1. On the soundbar,
 - Check that the soundbar has been properly connected to your home network (See “Connection with your home network” in the “CONNECT” chapter).
2. On your Android or iOS device,
 - a) Check that your Android or iOS device has been connected to the same network as the soundbar.
 - b) On a Chromecast-supported app, play music, tap the cast icon  and select the connected soundbar.



3. To exit from the music playback, switch to other sources.

6.7 Play through AirPlay

Through AirPlay, stream audio on your iOS device to the soundbar.

1. On the soundbar,
 - Check that the soundbar has been properly connected to your home network (See “Connection with your home network” in the “CONNECT” chapter).
2. On your iOS device,
 - a) Check that your iOS device has been connected to the same network as the soundbar.
 - b) To enter the Control Center on an iOS device, swipe down from the upper right corner (iOS 12 or later) or swipe up from the bottom edge (iOS 11 or earlier). Tap  to select the connected soundbar and then, start audio streaming from an app.

3. To exit from the music playback, switch to other sources.

NOTES:

- The soundbar can support audio streaming and cannot support video streaming.
- During Chromecast or AirPlay, music playback pauses on the current connected device when you start music playback on a second connected device.
- When the soundbar switches between your home Wi-Fi and wired network during AirPlay 2, music playback pauses and will resume in a few minutes, depending on the bandwidth condition of broadband. For the connection to your home wired network, see Step 3 under “Connection with your home network” in the Chapter “CONNECT”.

6.8 Multi-room playback

With the multi-room playback, you can stream music on your Android or iOS device to multiple Chromecast-enabled/AirPlay / Alexa speakers.

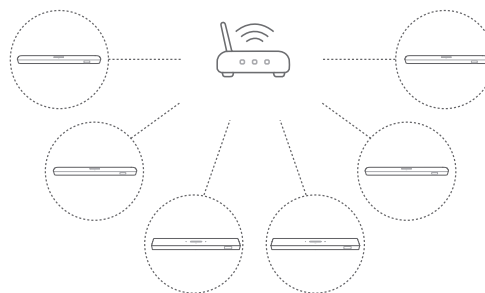

6.8.1 Chromecast built-in

1. Through the Google Home app, connect multiple Chromecast-enabled speakers to the same network, assign them to multiple rooms, and create groups as needed.
2. Run a Chromecast-enabled app on your smartphone or tablet.
3. Play music. Press  and select the grouped speakers.

NOTES:

- Refer to the Google Home app for more details.
- Depending on the bandwidth of your local network, you can stream music to up to 6 Chromecast-enabled speakers.

6.8.2 AirPlay

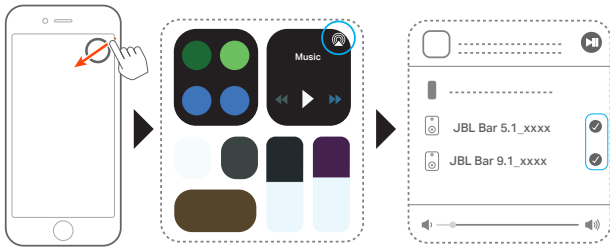

1. On an iOS device, enter the Control Center.
2. Tap to select multiple connected speakers as needed.
3. Start music streaming from an app.

6.8.3 Alexa MRM: Multi-Room Music

1. Check that you have associated the soundbar with your Amazon account through the JBL BAR Setup app (See “Through the JBL BAR Setup app” under “5.3 Connection with your home network” in the “5. CONNECT” chapter).
2. Through the Amazon Alexa app, create a Multi-room Music group for the soundbar. Refer to the Amazon Alexa app for more information.

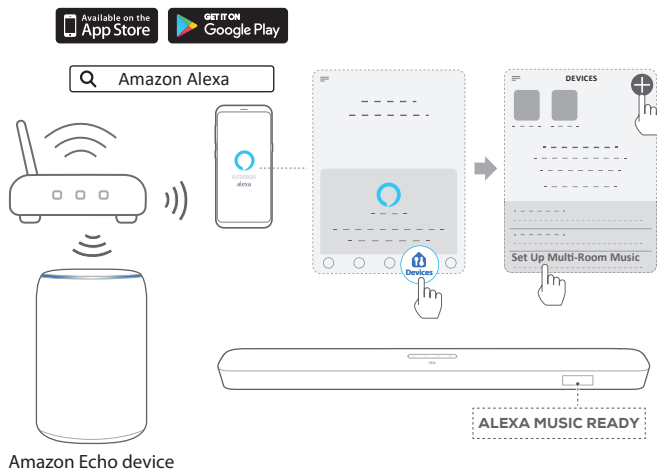

NOTES:

- Refer to the Amazon Alexa app for more details.

7. SOUND SETTINGS

Bass adjustment

1. Check that the soundbar and subwoofer are properly connected (See the “PLAY” chapter).
2. On the remote control, press repeatedly to switch between bass levels.
→ “LVL1” to “LVL5” is displayed (default: “LVL3”).

Audio sync

With the audio sync function, you can synchronize audio and video to make sure that no delay is heard from your video content.

1. On the remote control, press and hold **TV** for more than three seconds and then, press **+**.
2. Within five seconds, press **+** or **-** on the remote control to adjust the audio delay and match with video.
→ The audio sync timing is displayed.

Smart mode

With the smart mode enabled by default, you can enjoy TV programs with rich sound effects. For TV programs such as news and weather forecasts, you can reduce sound effects by disabling the smart mode and switching to the standard mode.

Smart mode: EQ settings and JBL Surround Sound are applied for rich sound effects.

Standard mode: The preset EQ settings are applied for standard sound effects.

To disable the smart mode, do the following:

1. On the remote control, press and hold for more than three seconds and then, press **+**.
→ Current mode is displayed. “ON SMART MODE”: The smart mode is enabled.
2. Repeat Step 1.
→ You switch to another mode. “OFF SMART MODE”: The standard mode is enabled.
→ Next time you switch on the soundbar, the smart mode is enabled again automatically.

8. RESTORE FACTORY SETTINGS

By restoring the default settings defined at factories, you remove all your personalized settings from the soundbar.

- On the soundbar, press and hold \cup and G for more than 10 seconds.
 - “RESET” is displayed.
 - The soundbar shows “LOAD” and “STDBY” and then, goes to standby mode.

9. SOFTWARE UPDATE

For optimal product performance and your best user experience, JBL may offer software updates for the soundbar system in the future. Please visit www.jbl.com or contact JBL call center to receive more information about downloading update files.

Updating online

Connect the soundbar to your home network. Updating online happens automatically if software updates are available.

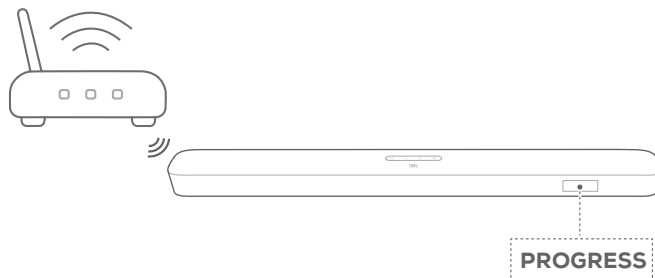

During software updating, “PROGRESS” and the completed percentage are displayed. When software updating is complete, the soundbar shows “LOAD” and “STDBY” and then, goes to standby mode.

Updating through a USB storage device

1. Check that you have saved the software update file to the root directory of a USB storage device.
2. Connect the USB device.
3. To enter the software update mode, press and hold \cup and - on the soundbar for more than 10 seconds.
 - “UPDATE MODE” is displayed.
 - “WAIT”: Software updating underway
 - “DONE”: Software updating completed
 - The soundbar returns to the last selected source.

NOTES:



- Keep the soundbar powered on and the USB storage device mounted before software updating is complete.

10. RE-CONNECT THE SUBWOOFER

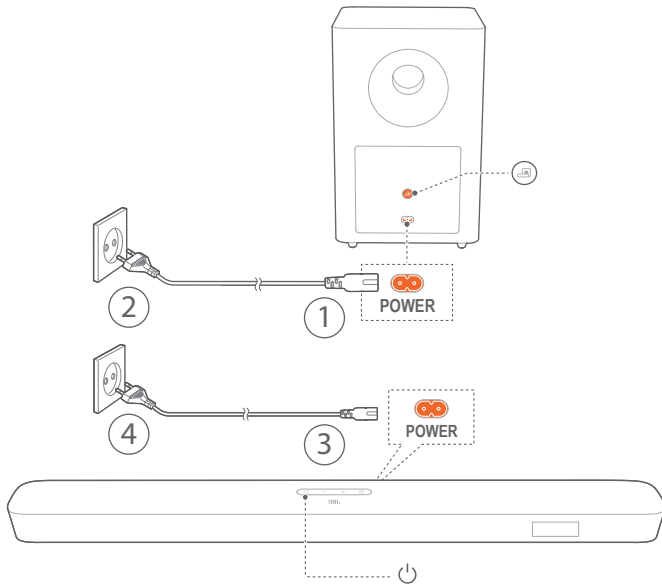
The soundbar and subwoofer are paired at factories. After power-on, they are paired and connected automatically. In some special cases, you may need to pair them again.



To re-enter the subwoofer pairing mode

1. On the rear panel of subwoofer, press and hold  until it turns fast flashing white.
2. To enter the subwoofer pairing mode on the soundbar, press and hold  on the remote control for more than five seconds. Press - on the remote control.
 - "PAIRING": The subwoofer is ready for pairing.
 - "CONNECTED": The subwoofer is connected.

NOTES:

- The subwoofer will exit the pairing mode in three minutes if pairing and connection are not completed.  turns from fast flashing white to slow flashing white.

11. PRODUCT SPECIFICATIONS

General specification:

- Model: Bar 5.1 CNTR (Soundbar Unit), Bar 5.1 SUB (Subwoofer Unit)
- Power supply: 100 - 240V AC, ~ 50/60 Hz
- Total speaker power output (Max. @THD 1%): 550 W
- Soundbar output power (Max. @THD 1%): 5 x 50 W
- Subwoofer output power (Max. @THD 1%): 300 W
- Soundbar transducer: 5 racetrack drivers + 2 x 1.25" side-firing tweeters
- Subwoofer transducer: 10"
- Networked standby power: < 2.0W
- Operating temperature: 0°C - 45 °C

HDMI specification:

- HDMI Video input: 1
- HDMI Video output (With Audio return channel): 1
- HDMI HDCP version: 2.3

Audio specification:

- Frequency response: 34 Hz - 20 KHz
- Audio inputs: 1 Optical, Bluetooth, USB (USB MP3 playback is available in US version. For other versions, USB is for Service only. Hard Disk Drive is not supported.)

USB specification (Audio playback is for US version only):

- USB port: Type A
- USB rating: 5 V DC / 0.5 A
- Supporting file format: mp3
- MP3 Codec: MPEG 1 Layer 2/3, MPEG 2 Layer 3, MPEG 2.5 Layer 3
- MP3 sampling rate: 16 - 48 KHz
- MP3 bitrate: 80 - 320 kbps

Wireless specification:

- Bluetooth version: 4.2
- Bluetooth profile: A2DP V1.2, AVRCP V1.5
- Bluetooth frequency range: 2402 MHz - 2480 MHz
- Bluetooth Max. transmitting power: < 11 dBm (EIRP)
- Modulation Type: GFSK, $\pi/4$ DQPSK, 8DPSK
- Wi-Fi network: IEEE 802.11 a/b/g/n/ac (2.4GHz/5GHz)
- 2.4G Wi-Fi frequency range: 2412 - 2472 MHz (2.4GHz ISM Band, USA 11 Channels, Europe and others 13 Channels)
- 2.4G Wi-Fi Max. transmitting power: < 20 dBm
- Modulation Type: DBPSK, DQPSK, CCK, QPSK, BPSK, 16QAM, 64QAM
- 5G Wi-Fi frequency range: 5.15 - 5.35GHz, 5.470-5.725GHz, 5.725 - 5.825GHz
- 5G Wi-Fi Max. transmitting power: < 22 dBm
- Modulation Type: QPSK, BPSK, 16QAM, 64QAM, 256QAM
- 5G Wireless frequency range: 5736.35 - 5820.35 MHz

- 5G Max. transmitting power: < 9 dBm (EIRP)
- Modulation Type: $\pi/4$ DQPSK

Dimensions

- Dimensions (W x H x D): 1018 x 58 x 100 mm / 40.1" x 2.3" x 3.9" (Soundbar); 305 x 440 x 305 mm / 12.0" x 17.3" x 12.0" (Subwoofer)
- Weight: 3.06 Kg (Soundbar); 10.62 Kg (Subwoofer)
- Packaging dimensions (W x H x D): 1105 x 382 x 488 mm / 43.5" x 15.0" x 19.2"
- Packaging weight (Gross weight): 16.8 Kg

12. TROUBLESHOOTING

Never try to repair the product yourself. If you have problems using this product, check the following points before you request services.

System

The unit will not turn on.

- Check if the power cord is plugged into power and the soundbar.

The soundbar has no response to button pressing.

- Restore the soundbar to factory settings (See the "RESTORE FACTORY SETTINGS" chapter).

Sound

No sound from soundbar

- Make sure that the soundbar is not muted.
- Select the correct audio input source on the remote control.
- Connect the soundbar to your TV or other devices properly
- Restore the soundbar to its factory settings by pressing and holding \odot and G on the soundbar for more than 10 seconds.

Distorted sound or echo

- If you play audio from your TV through the soundbar, make sure that your TV is muted or the built-in TV speaker is disabled.

Audio and video are not synchronized.

- Enable the audio sync function to synchronize audio and video (See "Audio sync" in the "SOUND SETTINGS" chapter).

Bluetooth

A device cannot be connected with the soundbar.

- Check if you have enabled Bluetooth on the device.
- If the soundbar has been paired with another Bluetooth device, reset Bluetooth (see "To connect to another device" under "Bluetooth connection" in the "CONNECT" chapter).
- If your Bluetooth device has ever been paired with the soundbar, reset Bluetooth on the soundbar, unpair the soundbar on the Bluetooth device, and then, pair the Bluetooth device with the soundbar again (see "To connect to another device" under "Bluetooth connection" in the "CONNECT" chapter).

Poor audio quality from a connected Bluetooth device

- The Bluetooth reception is poor. Move the source device closer to the soundbar, or remove any obstacle between the source device and the soundbar.

The connected Bluetooth device connects and disconnects constantly.

- The Bluetooth reception is poor. Move the source device closer to the soundbar, or remove any obstacle between the source device and the soundbar.

Wi-Fi

Failed to connect to Wi-Fi.

- Make sure that Wi-Fi is turned on.
- Make sure that you have selected the right network and entered the correct password.
- Make sure that your router or modem is turned on and within the range.
- Make sure that your soundbar is connected to the same wireless LAN as your smartphone or tablet.

The Google Home app cannot find the device.

- Make sure that your soundbar is powered on.
- Make sure that your network is working properly.
- Make sure that your router or modem is powered on and within the range.

Remote control

The remote control does not work.

- Check if the batteries are drained. If so, replace them with new ones.
- Reduce the distance and angle between the remote control and the main unit.

Failed to complete the TV remote control learning.

- Check if you are using an infra-red TV remote control. The IR learning is not supported by a Bluetooth TV remote control.

13. TRADEMARKS



The Bluetooth® word mark and logos are registered trademarks owned by Bluetooth SIG, Inc. and any use of such marks by HARMAN International Industries, Incorporated is under license. Other trademarks and trade names are those of their respective owners.



The terms HDMI, HDMI High-Definition Multimedia Interface, and the HDMI Logo are trademarks or registered trademarks of HDMI Licensing Administrator, Inc.



The Wi-Fi CERTIFIED™ Logo is a certification mark of the Wi-Fi Alliance®.



Manufactured under license from Dolby Laboratories. Dolby, Dolby Audio, Dolby Vision, and the double-D symbol are trademarks of Dolby Laboratories.



Google, Google Play, Google Home and Chromecast built-in are trademarks of Google LLC.



Apple, AirPlay, iPad, iPad Air, iPad Pro, and iPhone are trademarks of Apple Inc., registered in the U.S. and other countries.

Use of the Works with Apple badge means that an accessory has been designed to work specifically with the technology identified in the badge and has been certified by the developer to meet Apple performance standards.

To control this AirPlay 2-enabled speaker, iOS 11.4 or later is required.



Amazon, Echo, Alexa, and all related logos are trademarks of Amazon.com, Inc. or its affiliates.



Use your phone, tablet or computer as a remote control for Spotify. Go to spotify.com/connect to learn how

The Spotify Software is subject to third party licenses found here: <https://www.spotify.com/connect/third-party-licenses>

14. OPEN SOURCE LICENSE NOTICE

This product contains open source software licensed under GPL. For your convenience, the source code and relevant build instruction are also available at <http://www.jbl.com/opensource.html>.

Please feel free to contact us at:

Harman Deutschland Gmb

HATT: Open Source, Gregor Krapf-Gunther, Parkring 3

85748 Garching bei Munchen, Germany

or OpenSourceSupport@Harman.com if you have additional question regarding the open source software in the product.



HARMAN International Industries,
Incorporated 8500 Balboa Boulevard,
Northridge, CA 91329 USA
www.jbl.com

© 2020 HARMAN International Industries, Incorporated.
All rights reserved.

JBL is a trademark of HARMAN International Industries, Incorporated, registered in the United States and/or other countries. Features, specifications and appearance are subject to change without notice.